

Experimental and Numerical Investigation on Fatigue Crack Paths in Welded Structural Joints

M. Mouri, Y. Sumi and Y. Kawamura

Department of Systems Design for Ocean-Space, Yokohama National University
79-5 Tokiwadai, Hodogaya-ku, Yokohama 240-8501, Japan
e-mail: mouri@seawolf.shp.ynu.ac.jp

***ABSTRACT.** In case of marine structures, fatigue cracks may initiate and propagate due to repeated wave exciting pressure. Propagation of fatigue crack causes not only instantaneous fracture but also loss of serviceability such as the oil and/or water tightness of a compartment. Fatigue cracks could be detected by periodic inspections, but it is sometimes difficult to find a crack due to bad accessibility or visibility. In order to manage the fatigue crack propagation, it is desirable to develop design method that renders cracks detectable and non-hazardous even though they may initiate. Such a design concept is studied by analyses and experiments in the present paper. A simulation system is also used as a tool to obtain the paths and growth-behavior of a fatigue crack. This system may also be used to determine the timing of repair of fatigue cracks found during in-service inspection.*

INTRODUCTION

We investigate a possibility of the design method, which optimizes structural details in such a way that fatigue cracks could be detectable and non-hazardous even though they may initiate. Case studies are carried out by FE-analyses and fatigue tests which model the end of a girder of a double-hull ship structure. By using the crack path prediction system for fatigue crack propagation (CP-SYSTEM), the simulated and experimentally observed crack growth behavior are compared so that the applicability of the system is verified.

FATIGUE DESIGN OF A STRUCTURAL DETAIL AT THE END OF A GIRDER

Figure 1 shows a structural detail at the end of a girder of a double hull crude oil carrier, which may have two locations of structural discontinuities; one is the connection between the web plate and the face-plate (location "A" in Fig.1), and the other is the connection between the web plate of a girder and the inner hull (location "B" in Fig.1). Fatigue cracks may initiate at these two sites. The dominant loads acting at the end of the girder are axial loads due to combined global and local structural responses. After

crack initiation, possible crack paths could be categorized into the following three types as illustrated in Fig. 1;

(a-1) A fatigue crack initiates at site A and propagates in a curved fashion, or is going to be arrested in the web plate of the girder.

(a-2) A fatigue crack initiates at site A and propagates towards the inner hull.

(b) A fatigue crack initiates at site B and breaks through the inner hull and might penetrate into the web plate beneath the inner hull.

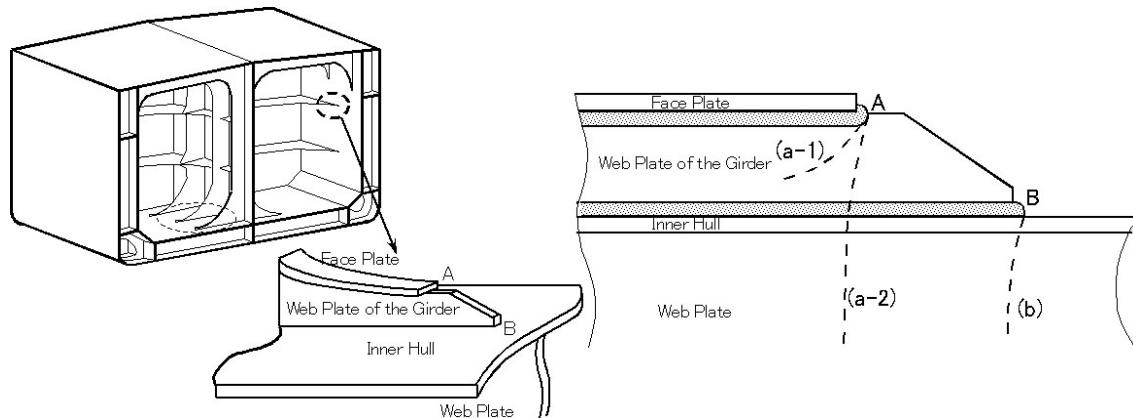

Figure 1. Configuration of a girder in a cargo tank and potential fatigue damage at the end of a girder.

In order to keep oil or water tightness by the inner hull, fatigue crack paths (a-2) and (b) should be prevented, while crack path (a-1) may be acceptable. Furthermore, crack paths of type (a-1) might function as an indicator of fatigue damage at end of girder. In order to realize this design concept, it is essential that the crack initiation life at site B is long enough in comparison with the sum of the initiation life at site A and the propagation life in the web. In the following section, FE-analyses and fatigue tests were carried out in order to confirm the applicability of the present fatigue design concept.

INITIATION SITES OF FATIGUE CRACKS

Estimation of Initiation Sites of Fatigue Cracks by FE-Analysis

In order to investigate the influences of structural details on the initiation sites of fatigue cracks, FE-analyses are carried out, where the relation between the geometry of structural details and the corresponding stresses are compared. The right-hand side of Fig. 2 shows the analysis model, where the loading condition is the uniform pressure applied on the lower flange of the girder. Twelve models are used by changing the two design parameters, d_1 and d_2 , and a general – purpose FEM code, 'I-DEAS Master Series' is used for the stress analyses by using a uniform finite element mesh size at the stress concentration regions.

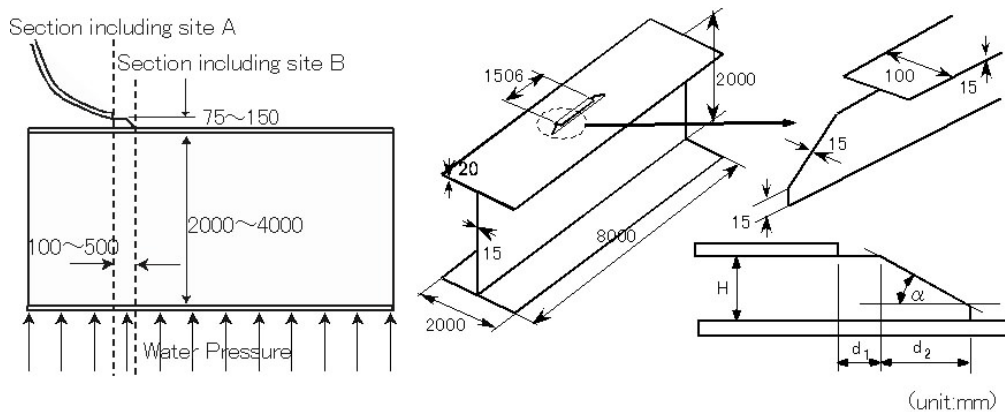

Figure 2. Geometry of the girder and FE-model for prediction of crack initiation.

Based on the FE-analyses, the relationship between design parameters and estimated crack initiation sites are plotted in Fig.3, where α and d_1/h are taken as the design parameters. In the upper left region in the design space, the local stress at the location B is higher than that at the location A. This means that a fatigue crack may initiate at B, and the crack propagation may be of the type (b) in Fig.1. On the contrary, a structural detail in the lower-right region has a higher local stress at the location A, which may lead to fatigue cracking from A. With increasing d_1/h the load is fully transferred at the location A, so that the principal stress is almost parallel to the longitudinal direction. This means that the fatigue crack may be of the type (a-2) in Fig.1.

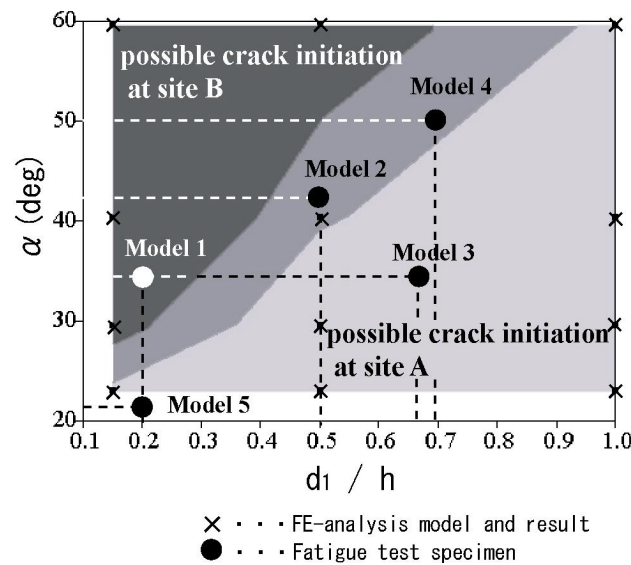

Figure 3. Relationship between design parameter and prediction of crack initiation sites.

In the region in-between these two regions we may expect a structural detail such that a fatigue crack initiates at the location A, and propagates in an inclined direction as categorized by (a-1) in Fig.1, because the direction of the maximum principal stress is considerably inclined to the longitudinal direction due to the stress flow into the attachment at the structural discontinuity.

Investigation of Initiation Sites of Fatigue Cracks by Fatigue Tests

Since welding residual stress constitutes a major cause of crack initiation as well as stress concentration, it is difficult to predict a crack initiation site only by an elastic stress analyses without taking account of the residual stress effect. In order to confirm applicability of the FE-analyses in the previous subsection, fatigue tests are carried out by using five specimens with different structural details. Although fatigue tests have several constraints on the capacity of testing machine, time, space, and cost, the specimens are designed so that the stress condition is equivalent to a real ship at the critical locations A and B. Considering the geometry and the loading condition of a real ship as shown in Fig. 2, nominal stress at the locations A and B may be equal with each other. Furthermore the geometry and the thickness of the structural details of the specimens should coincide with those of a real ship so that the influence of welding residual stress is properly taken into consideration at the site of crack initiation. Considering the above conditions, the specimens are designed such that they consist of an I-beam (height: 142mm) with a stiffener, to which a face-plate is attached on the top edge (see Fig.4). Nominal stresses at the locations A and B are calculated by the extrapolation using smoothed stress distribution derived by FE-analyses of 3-D solid model. Design parameters d_1 and d_2 are chosen to cover the design-space as illustrated in Fig.3. According to the FE prediction, the initiation site of fatigue cracks may be the location B for Model 1, while it may be the location A for the other four specimens.

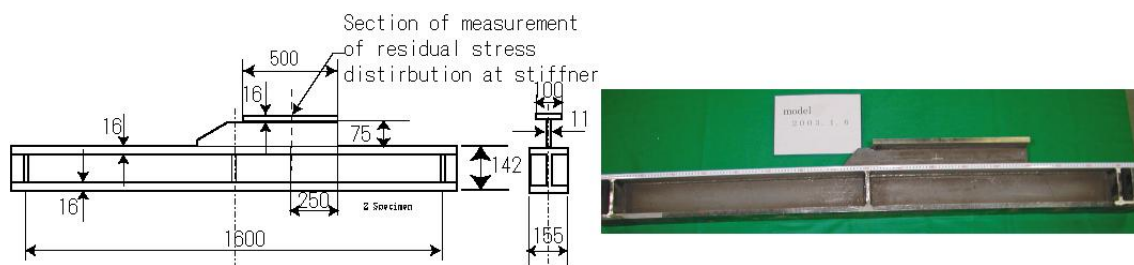

Figure 4. Model 2 specimen for fatigue test.

The material used is class KA36 ship structural steel and the detailed sizes of each specimen are listed in Table 1. The applied nominal stress range is set to 85 MPa at the critical points. All fatigue tests were carried out at room temperature in atmospheric condition and repetition frequency was set at 3 Hz, and the stress ratio was set at 0.05. The strain gages were pasted on in the vicinity of welded toe at the sites A and B in order to predict crack initiation lives which are considered to be corresponding to the

5% decrease of the applied strain amplitude [1]. The crack gages were pasted on the both sides of stiffener plate below the location.

The crack initiation life at each site was listed in Table 1. A fatigue crack initiated only at the site B in Models 1 and 5, in which they propagated in the upper flange of the I-beam and finally failed. For the other three specimens, although fatigue cracks were initiated at the site A, these cracks were arrested in the middle part of stiffener plate, while other fatigue cracks were initiated at site B afterwards and failed similar to Models 1 and 5. The ratios of N_{cb} , initiation lives at the site B, to N_{ca} , initiation lives at the site A, were within the range from 1.52 to 3.66 (see Table 1).

The predictions were found to be in good agreement with experimental results except for Model 5. The cause of disagreement might be the effect of lower tensile residual stress of Model 5 at the site A, where the welded toe was very close to the free edge of stiffener like that of Model 1.

Table 1. Design parameters and crack initiation lives (N_c) of fatigue tests.

Specimen	d_1 (mm)	d_2 (mm)	Estimation of crack initiation site	Crack initiation lives (Cycles)		N_{cb}/N_{ca}
				site A (N_{ca})	site B (N_{cb})	
Model 1	15	85	B		60000	-
Model 2	37	65	A	56100	96300	1.72
Model 3	52	85	A	125600	191300	1.52
Model 4	50	50	A	46500	170000	3.66
Model 5	15	150	A		90500	-

FATIGUE CRACK PATHS AND PROPAGATION BEHAVIOR

Experimental Observation

The paths of the cracks, which were initiated at the location A, were measured by an optical method and illustrated in Fig. 5(a). The crack path of Model 2 is similar to that of Model 4 and both cracks are arrested at similar position. In the case of Model 3, the crack from the site A propagates further in comparison with the other specimens. Although there is no appreciable difference of crack paths on the three specimens, the crack path just after the initiation of Model 3 seems to be less inclined than those of other specimens. This phenomenon may reflect the stress distribution obtained by the elastic stress analyses in the previous section.

The reason of the crack arrest observed in Models 2, 3 and 4 in middle of stiffener plate might be the effect of welding residual stress. The distribution of residual stress, 200mm away from the site A in the longitudinal direction was measured by a sectioning technique by using the Model 2 after failure. The measured longitudinal residual stresses are shown in Fig. 5(b), where the maximum compressive stress is -190 MPa at the middle of the stiffener plate. Although the residual stress near the location A may be

slightly relaxed due to the effect of the free edge, general tendency of the distribution of residual stress is obtained by this measurement. It seems that the major reason of the crack arrest could be the compressive welding residual stress.

From these experimental results, it may be possible to propose a design method, which optimizes structural details in such a way that fatigue cracks could be detectable and non-hazardous even though they may initiate. It seems that the fatigue cracks observed in Models 2, 3, and 4 are such cases.

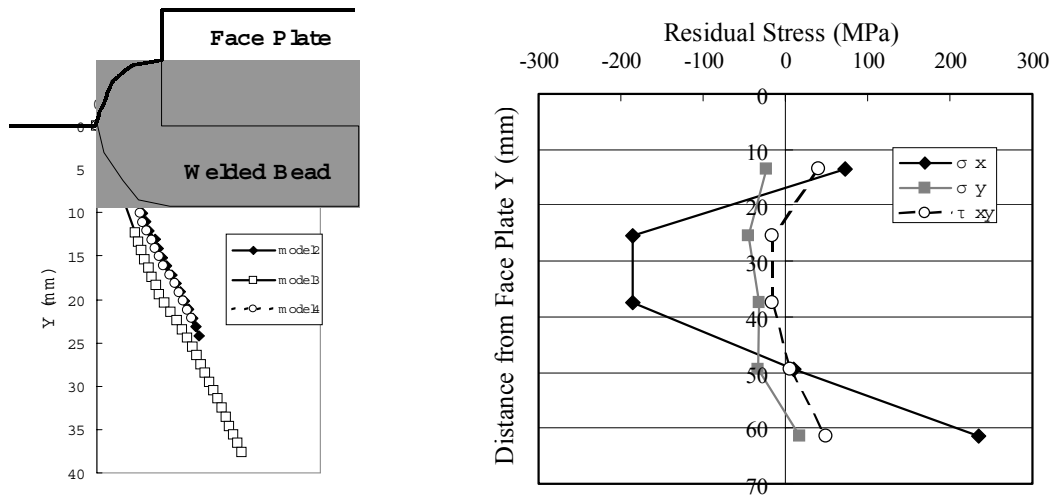

(a) Crack paths of each specimen (b) Residual stress in the attachment

Figure 5. Experimental results.

Simulation of Fatigue Crack Paths by CP-SYSTEM

Crack path prediction system, CP-SYSTEM, has been developed [2]. The three features of the system are briefly described below:

- (1) The system employs a step-by-step finite element approach with a specially developed re-meshing technique, where a fatigue crack is modeled as a two-dimensional crack in a plate. Accurate stress intensity factors are obtained by the superposition of analytical and finite element solutions. Then, the crack tip is moved to a point on a predicted path, which is obtained by using the local symmetry criterion. Fatigue crack paths and crack propagation lives are obtained by the repetition of this process.
- (2) This system can be applied to a crack in a three-dimensional welded structure. The crack-propagation zone is connected to the surrounding three-dimensional structure modeled by a general-purpose finite-element code using the substructure (super-element) technique. An example of FE-model of a surrounding structure of the specimen, and the corresponding FE-model of the crack propagating domain by the CP-SYSTEM is illustrated in Fig. 6. A general-purpose structural analysis code 'MSC NASTRAN' is used to model the surrounding three-dimensional

structure.

- (3) This system can take into account the effect of distribution of welding residual stress in the crack propagating region so that the accelerated and retarded crack propagation in the tensile and compressive residual stress field may respectively be evaluated in the simulation.

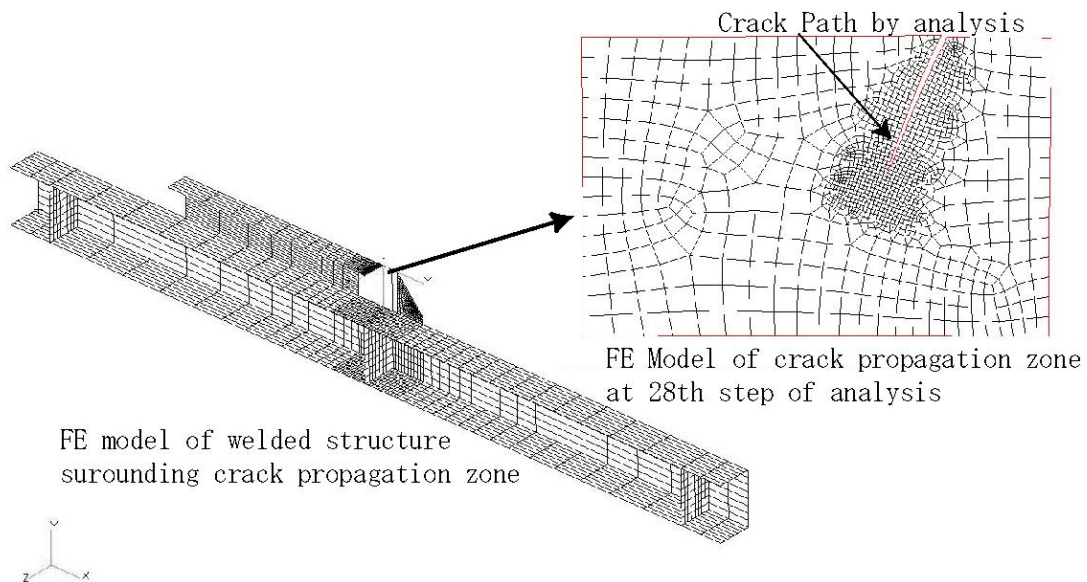
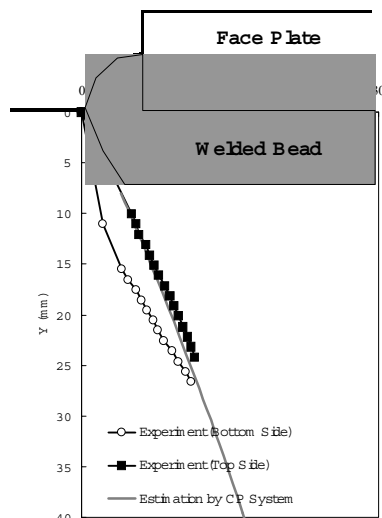

Figure 6. FE-model of Model 2 specimen for CP System.

The crack path of the test specimen, Model 2, is simulated by using CP-SYSTEM. The simulated path is compared with the experimental results in Fig. 7(a), where different crack paths are observed on the both sides of the plate in the experiment for the range of short cracks. This may be due to the influence of the shape of weld bead at the location. The crack path obtained by CP-SYSTEM is almost in-between the experimentally measured crack paths on the both sides, and they are in fairly good agreement with each other.

In Fig. 7(b), the simulated crack propagation life is compared with experimental results, where the prediction of the crack propagation life is obtained by taking account of the effect of the residual stress measured and illustrated in Fig. 5(b). In the experiment, the fatigue crack growth seems to be considerably retarded and almost arrested in middle part of the attached plate. The simulated results exhibit similarly retarded phenomena of the fatigue crack growth.

It is found that the present simulation method is very useful for the prediction of fatigue crack paths and the crack propagation lives, so that it can be applied to the fatigue design and the remaining life assessment of an actual structural detail of a welded structure.



(a) Crack paths

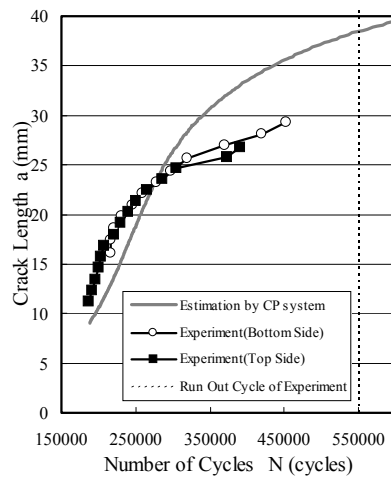

(b) Fatigue crack propagation lives

Figure 7. Experimental and predicted results for Model2 specimen.

CONCLUSIONS

It has been found by the present case study that there exists a possibility of the fatigue design, which optimizes structural details in such a way that fatigue cracks could be detectable and non-hazardous even though they may initiate. It is confirmed that the present simulation method is very useful for the prediction of fatigue crack paths and the crack propagation lives, so that it can be applied to the fatigue design and remaining life assessment of an actual structural detail of a welded structure.

ACKNOWLEDGEMENTS

This work has been supported by the Program for Promoting Fundamental Transport Technology Research (Project No.2001-03) from Corporation for Advanced Transport and Technology (CATT), and by the fund from Japan Ship Classification Society (Class NK). The authors are grateful for their support.

REFERENCES

1. Yagi, J., Machida, S., Tomita, Y., Matoba, M. and Soya, I. (1991) *Journal of the Society of Naval Architects of Japan* **169**, 289- 299 (in Japanese).
2. Sumi, Y. (2003) Computational crack path prediction for ship structure details. *Proceedings of the Conference on Fatigue Crack Paths (FCP 2003)*.